



SOSEN LED Driver, Your Smart Choice

Specifications

SS-150GA-E Series LED Driver

Model: SS-150GA-E62*

Description: 150W LED Driver

Rev.: V00

Release Date: 2023-10-08

SS-150GA-E Series LED Driver

SOSEN
LED DRIVER



LED DRIVER

GA-E Series



Features:

- Efficiency up to 92%
- Output current can be adjusted by NFC(DALI-2)
- Isolated dimming: DALI-2, 0-10V, PWM, Resistor
- Communication Function With PC
- Timing and Negative logic programmable
- ELA
- Suitable for Class I / II luminaires
- Protections: SCP/OTP/OVP/OPP/Power automatic derating at AC low line voltage input
- Surge protection: CM: 10kV(For Class I), DM: 6kV
- IP67
- Warranty: 5 years



RoHS

IP67

Description:

GA-E Series are constant current LED Driver with wide O/P voltage range and adjustable O/P current by program. LED luminaries manufactures can easily design luminaries and reduce cost.

Applications:

High Pole lighting, High bay lighting, Stadium lighting, Plant lighting, Fish lighting, Street lighting, Tunnel lighting, Stage lighting

Model List:

Model	AC Input Range	Max. Pout	Vout Range	Full Power Vo Range	Iout	THD(Typ.)	PF(Typ.)	Eff.(Typ.)	Max.Tc
SS-150GA-E62*	100-305Vac	150W	30-62V	40-62V	0.7-3.75A	8%	0.98	91.5%	90°C

Note:

1. Default Tested: at 220Vac, full load, Ta 25°C.

2. The performance of the LED Driver can be guaranteed within the full power Vo range. The voltage lower than full power Vo range, it is need to test the performance with the LED module.

SS-150GA-E Series LED Driver

“*” Means Additional Function

“*”	1-10V/PWM Dim /Resistor Or 10-0V (suffix:B)	DALI (suffix:D)	NFC	Class I	Class II	Remark
B	✓			✓		
BE	✓				✓	
D		✓	✓	✓		
DE		✓	✓		✓	

Input Characteristics:

Parameter	Min.	Typ.	Max.	Remark
AC Input Range	100Vac	220-240Vac	305Vac	Reference Derating Curve
Input Frequency Range	47Hz	50/60Hz	63Hz	
Max Input Current			0.8A	220Vac, Full load
Max Input Power			170W	220Vac, Full load
Max Inrush Current(220Vac)			75A	Cold start
No Load Power			5W	220Vac/50Hz, No load
Power Factor	0.95	0.97		220Vac/50Hz, Full load
	0.90			220-277Vac, 70-100% load
THD		8%	10%	220Vac/50Hz, Full load
			20%	220-277Vac, 70-100% load

SS-150GA-E Series LED Driver

Output Characteristics:

Parameter	Min.	Typ.	Max.	Remark
O/P Voltage Range	30V		62V	Power derated @30-40V
Rated O/P Voltage	40V		62V	$P_o=V_o \cdot I_o=150W$, Full load
Rated O/P Current	2.4A		3.75A	3.75A for 40V, 2.4A for 62V
Adj. O/P Current (AOC) Range	0.7A		3.75A	
No Load Voltage			80V	
Efficiency @220Vac	89.5%	91.5%		Output 62V/2.4A, Test after burn-in
Efficiency @277Vac	90.0%	92.0%		Output 62V/2.4A, Test after burn-in
O/P Current Tolerance	-5%		+5%	
O/P Current Ripple(PK-AV)		5%	10%	Full load
Start-up Current Overshoot			10%	Full load
Start-up Time			0.5S	220Vac, Full load
Line Regulation	-2%		+2%	Full load
Load Regulation	-2%		+2%	
Temperature Coefficient	-0.03%/°C		+0.03%/°C	Tc:0°C~90°C
OTP	90°C	100°C	110°C	>Tc Typ., Current derating <Tc Min., Current recovery
Short Circuit Protection				Driver will not be damaged, Hiccup mode

SS-150GA-E Series LED Driver

Other Characteristics:

Parameter		Min.	Typ.	Max.	Remark	
0-10V Positive Dimming (Configurable)	Dim Vmax	0V		12V	DIM+ source current 110uA. Dimming prohibits reverse connection Configurable to 0-5V	
	Dim Range	10%Iomax		100%Ioset		
	Rec.Dim Range	0V		10V		
10-0V Negative Dimming (Configurable)	Rec.Dim Range	0V		10V	DIM+ sink current I _{max} 40uA. Dimming prohibits reverse connection Configurable to 5-0V	
PWM Dimming (Optional)	PWM High	9.8V		10.2V	DIM+ source current 110uA. Dimming prohibits reverse connection	
	PWM Low	0V		0.3V		
	Frequency	1KHz		2KHz		
	PWM Duty	0%		100%		
Resistor Dimming (Optional)	Resistance	0Kohm		100Kohm	Not available with negative logic	
	Dim Range	10%Iomax		100%Ioset	DIM+ source current 110uA .	
0-10V Dim to Off	Dim off	0.7V	0.8V	0.9V	If the led is less than maximum rated output voltage of 75%,the luminaries may possibly have slight light when dim-to-off. Thus the whole lighting system needs to be tested	
	Dim on	0.8V	0.9V	1.0V		
10-0V Dim to Off	Dim off	9.0V	9.2V	9.4V		
	Dim on	8.8V	9.0V	9.2V		
Lifetime(Tc≤80°C)		≥50,000 hours				80% load
MTBF		200,980 hours				220Vac,Full load, Ta=25°C (MIL-HDBK-217F)
IP Grade		IP67				
Tc		90°C				
Warranty		5 years			Tc: 80°C	
Net Weight		680g				
Dimension		165mm*66mm*35mm			L x W x H	

NOTE: All the parameters above are tested Ta 25°C and LED load, unless specified.

SS-150GA-E Series LED Driver

Environmental Requirements

Parameter	Min.	Typ.	Max.	Remark
Operating Temperature(Tcase)	-40°C	25°C	+90°C	
Storage Temperature	-40°C	25°C	+90°C	
Operation Humidity	10%RH		90%RH	
Storage Humidity	5%RH		95%RH	
Altitude	-65m		4000m	

Safety and EMI/EMS Standards

Certification	Standard	Status	Remark
ENEC	EN 61347-1:2015 EN 61347-2-13:2014 EN 61347-2-13:2014/A1:2017	✓	
RCM	AS/NZS61347.2.13		
KC	K61347-1,K61347-2-13		
CCC	GB 19510.14-2009	✓	
CE	EN 61347-2-13:2014 EN61347-1:2008+A1:2011+A2:2013	✓	

EMI/EMS	Criterion	Remark
Conduction Emission	EN55015:2013+A1:2015 GB/T 17743	
Radiation Emission	EN55015:2013+A1:2015 GB/T 17743	
Harmonic Current Emissions	IEC/EN 61000-3-2 GB/T 17625.1	Class C
Surge	IEC/EN61000-4-5	DM: 6kV,CM: 8kV,Criterion B
	EN61547	DM: 6kV,CM: 10kV,Criterion B

SS-150GA-E Series LED Driver

Safety Test Items(B/D Model):

Safety Test Items	Technical Indicators			Remark
Insulation Requirements	UL Insulation Requirements	ENEC Insulation Requirements	CCC Insulation Requirements	
Input-Output	/	3000Vac	3750Vac	Reinforced insulation
Input-Case	/	1500Vac	1875Vac	Basic insulation
Input-Dim	/	3000Vac	3750Vac	Reinforced insulation
Output-Dim	/	1000Vac	1000Vac	Basic insulation
Output-Case	/	1000Vac	1000Vac	Basic insulation
Dim-Case	/	250Vac	500Vac	Basic insulation
Insulation Resistance	$\geq 10M\Omega$			Input-Output,Test voltage:500Vdc
Ground Resistance	$\leq 0.1\Omega$			25A/1min
Leakage Current	$\leq 0.75mA$			240Vac

NOTE:

1. SOSEN warrants the LED Driver itself complies with EMC standard. However, LED Driver's EMC should be re-checked when integrated into lighting systems due to unexpected interference of components.
2. Please short (ACL and ACN), (V+ and V-), (Dim+ and Dim -)when Hi-pot test.

SS-150GA-E Series LED Driver

Safety Test Items(BE/DE Model):

Safety Test Items	Technical Indicators			Remark
Insulation Requirements	UL Insulation Requirements	ENEC Insulation Requirements	CCC Insulation Requirements	
Input-Output	/	3000Vac	3750Vac	Reinforced insulation
Input-Case	/	3000Vac	3750Vac	Reinforced insulation
Input-Dim	/	3000Vac	3750Vac	Reinforced insulation
Output-Dim	/	1000Vac	1000Vac	Basic insulation
Output-Case	/	1000Vac	1000Vac	Basic insulation
Dim-Case	/	250Vac	500Vac	Basic insulation
Insulation Resistance	≥10MΩ			Input-Output,Test voltage:500Vdc
Ground Resistance	≤0.1Ω			25A/1min
Leakage Current	≤0.75mA			240Vac

NOTE:

1. SOSEN warrants the LED Driver itself complies with EMC standard. However, LED Driver's EMC should be re-checked when integrated into lighting systems due to unexpected interference of components.
2. Please short (ACL and ACN), (V+ and V-), (Dim+ and Dim -)when Hi-pot test.

Performance Curves:

Input Inrush Current

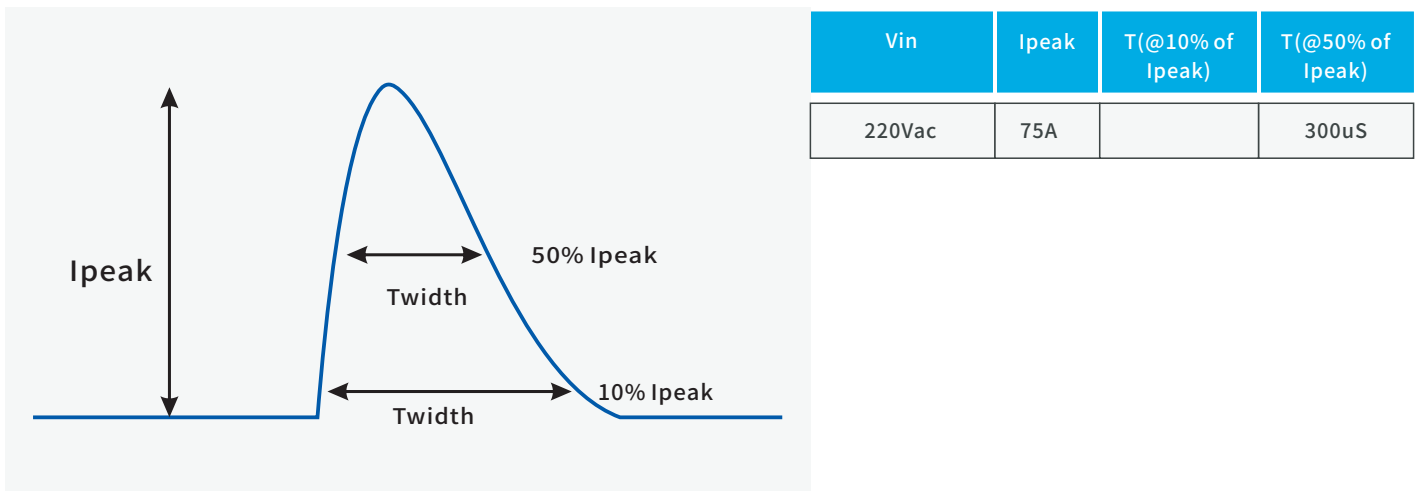

SS-150GA-E Series LED Driver

Performance Curves:

Output Voltage Vs. Output Current(Dim/AOC Window)

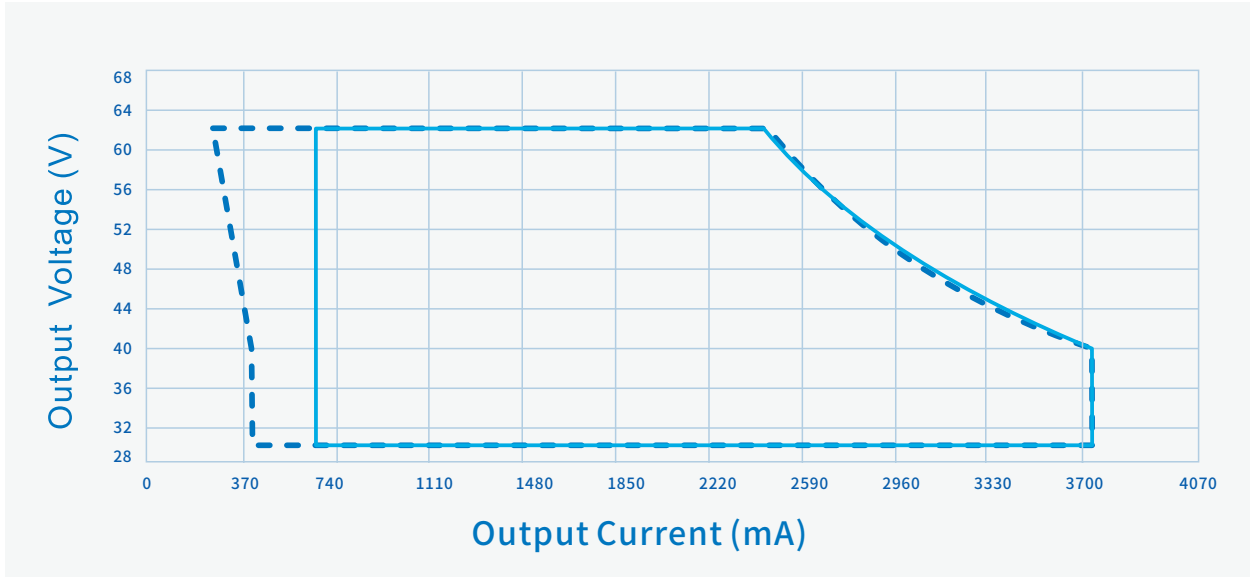

----- Dimming Window ————— AOC Window

Efficiency Vs. Output Voltage (Vin=220Vac)

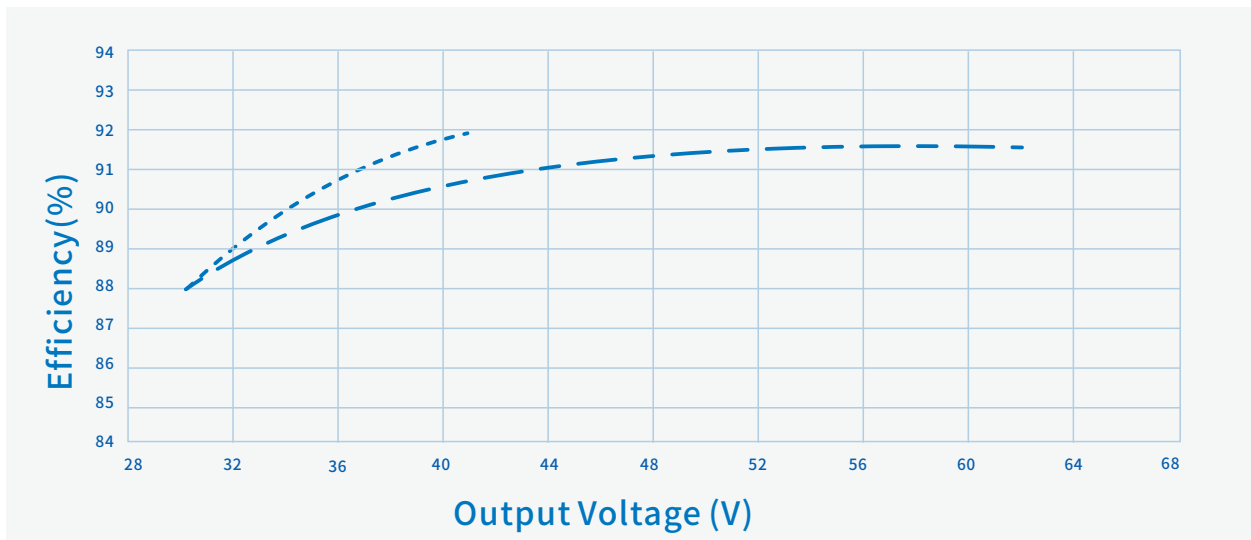

----- Io=3750mA - . - . - Io=2400mA

SS-150GA-E Series LED Driver

Performance Curves:

Power Factor Vs. Output Power

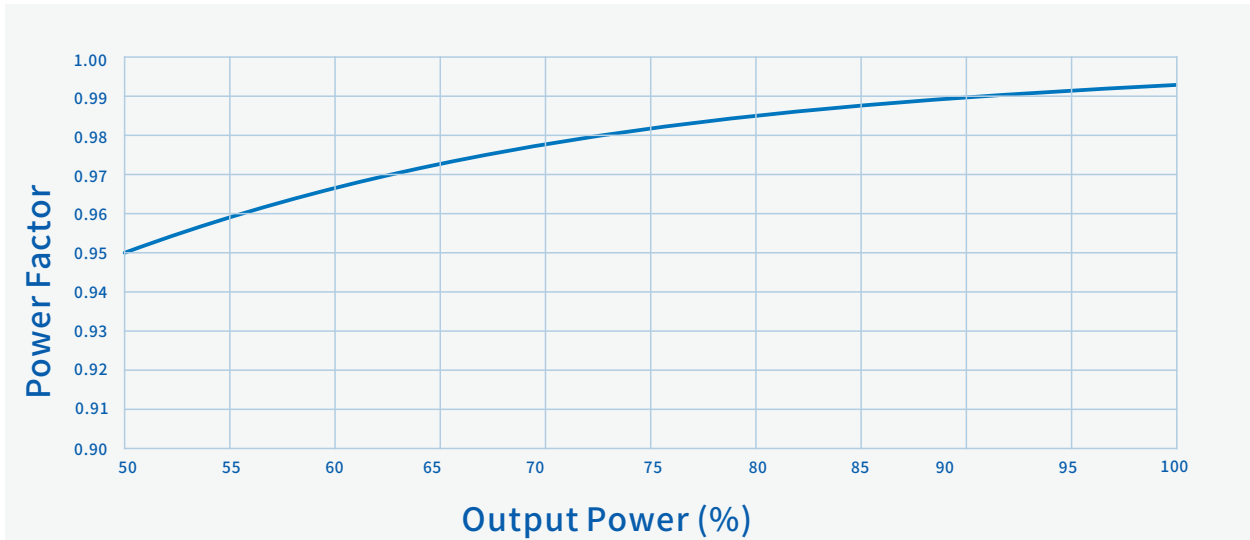

———— Vin=220Vac

THD Vs. Output Power

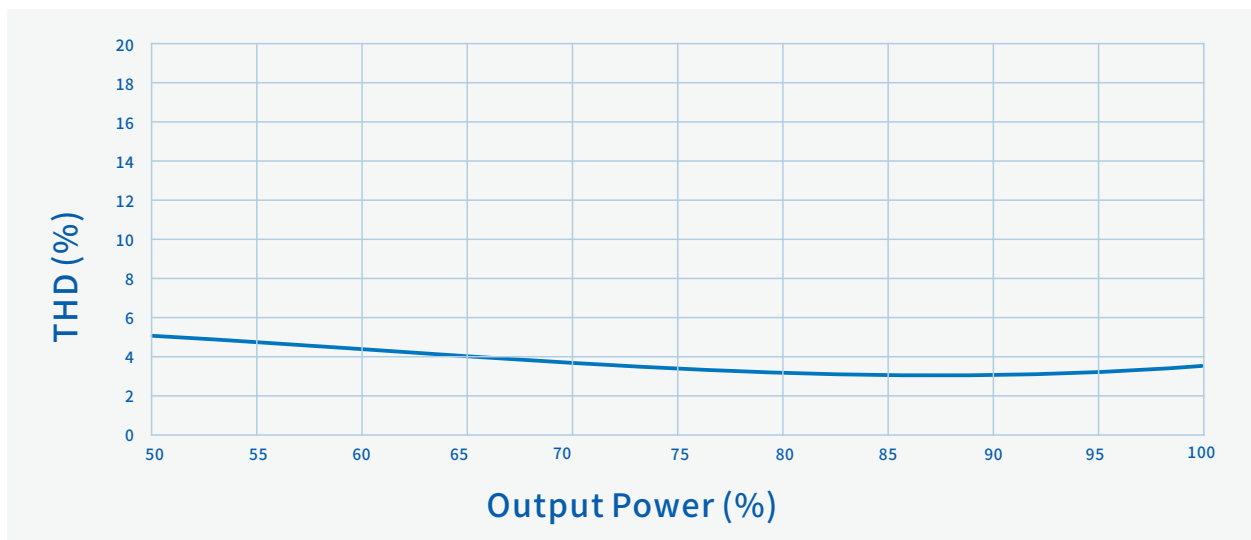

———— Vin=220Vac

SS-150GA-E Series LED Driver

Performance Curves:

Output power Vs. Input Voltage

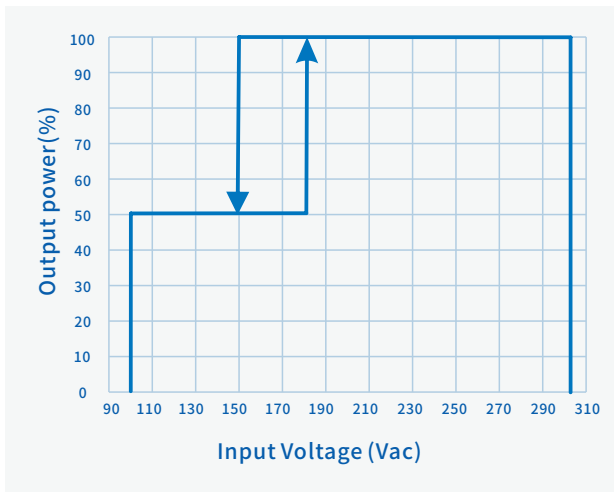

Output power Vs. Case Temperature

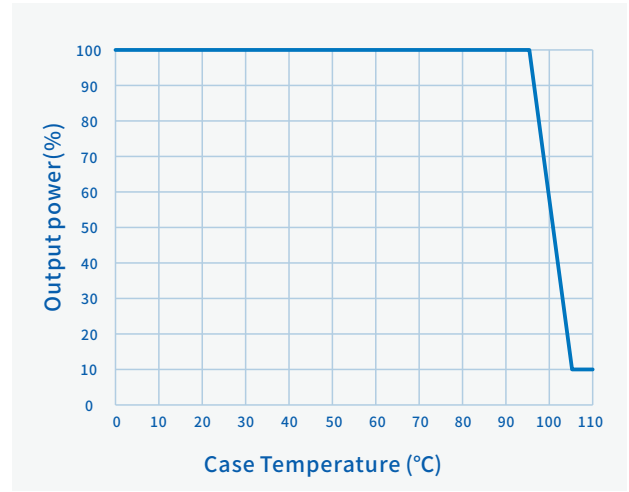

O/P Power Vs. Dimming

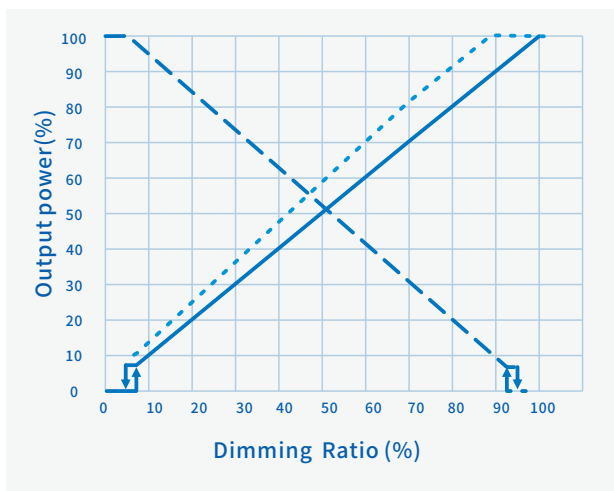

Lifetime Vs. Case Temperature

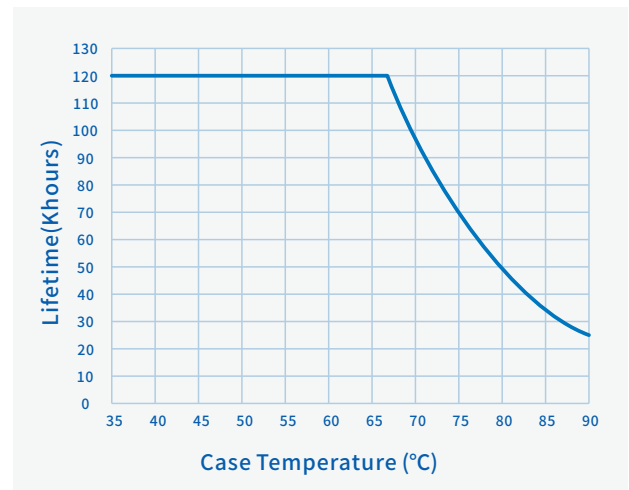

- 0-10V,0-5V,PWM
- - 10-0V,5-0V
- ... Resistor Dimming(100KΩ)

SS-150GA-E Series LED Driver

Performance Curves:

Output Power Vs. Dimming

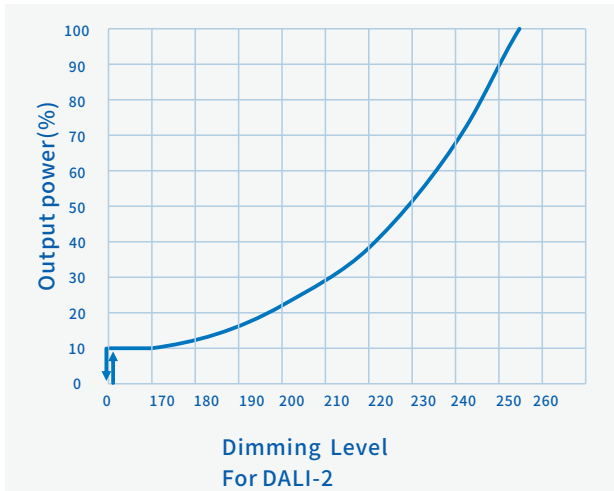

SS-150GA-E Series LED Driver

Programming connection diagram(B/BE Model):

Legacy Timer: Driver's O/P follows the pre-programmed timing curve after turn-on.
Auto-Adjust by Percentage: Driver's O/P will be adjusted by automatically changed dimming curve by the period percentage based on the latest 5 dimming curve.
Auto-Adjust by Mid-point: Driver's O/P will be adjusted by automatically changed dimming curve by mid-point based on the latest 5 dimming curve.

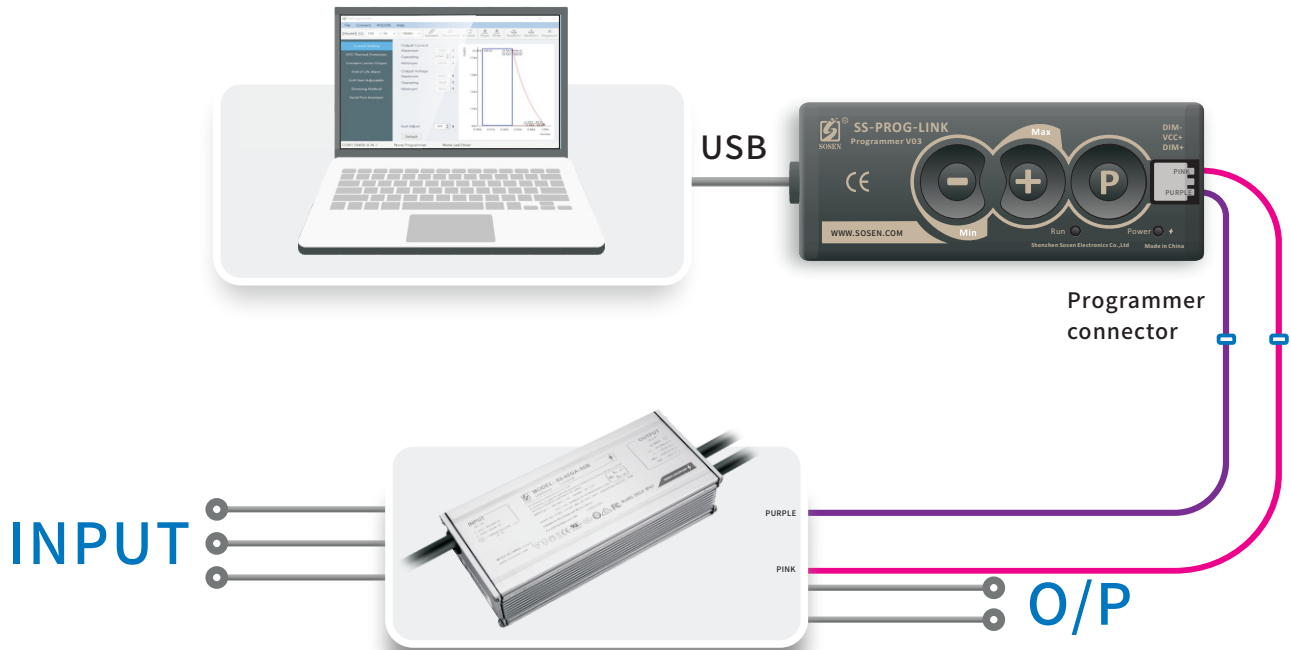

NFC Programming connection diagram(D/DE Model):

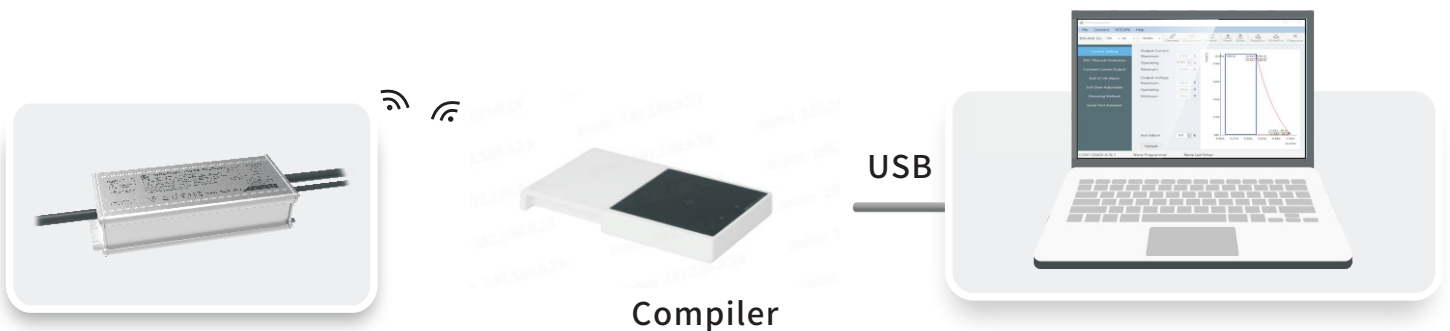

Constant Lumen Output

Constant Lumen Output are design to maintain fixture's stable output lumen by increasing driver's output current within driver's life span to counteract LED lumen degradation.

SS-150GA-E Series LED Driver

Mechanical Characteristics(B/D Model)

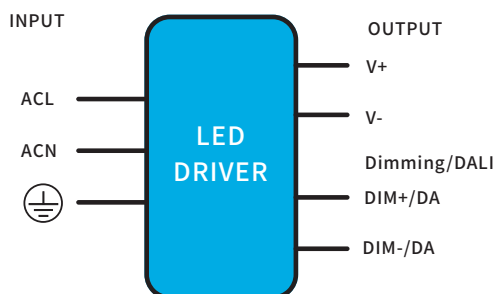

AC Input Cable(Exposed Length $450 \pm 10\text{mm}$):

EU model: H05RN-F, $3 \times 1.0\text{mm}^2$, O.D:7.3mm, Brown:L, Blue:N, Yellow/Green: \oplus

DC Output Cable(Exposed Length $250 \pm 10\text{mm}$):

EU model: H05RN-F, $2 \times 1.0\text{mm}^2$, O.D:7.0mm, Brown:V+, Blue:V-

DIM Cable(Exposed Length $220 \pm 10\text{mm}$):

UL model: STYLE 21996 2*22AWG, O.D: 4.9mm, Purple: DIM+/DA, Pink: DIM-/DA

Name Description	Standard Code	mm(In.)
Case Length	L3	149(5.87)
Case Width	W1	66(2.6)
Case Height	H	35(1.38)
Overall Length	L1	165(6.5)
Mounting Hole Length	L2	158(6.22)
Mounting Hole Width	W2	32(1.26)
TC Point Position	X	104(4.09)
TC Point Position	Y	35(1.38)

Note:

- Please follow the "LED Driver User Manual" obtained from SOSEN's official website for assembly.
- AC Input Cable, DC O/P Cable, DIM/AUX Power/Programming Cable: Peeled length of cable: $43 \pm 5\text{mm}$, Tinned length of wire: $10 \pm 2\text{mm}$

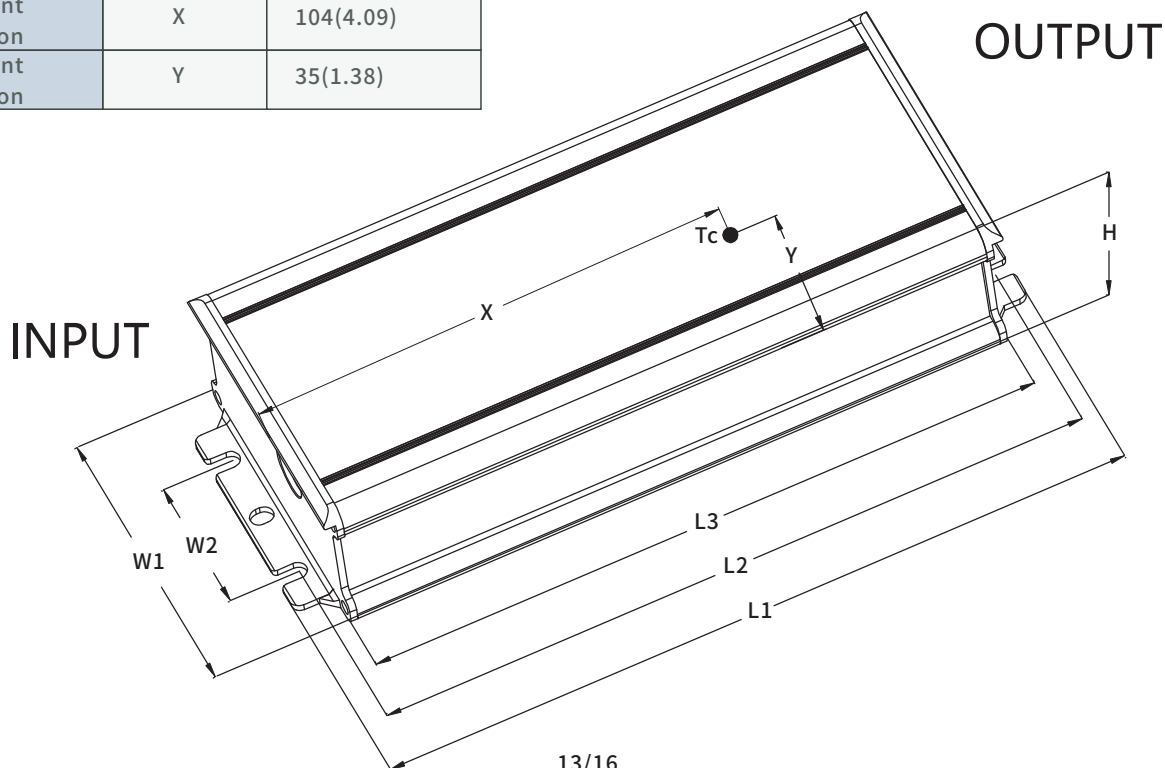

13/16

SS-150GA-E Series LED Driver

Mechanical Characteristics(BE/DE Model)

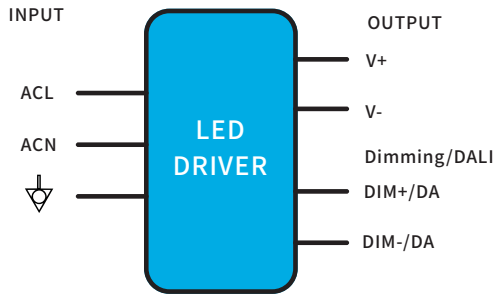

AC Input Cable(Exposed Length $450 \pm 10\text{mm}$):

EU model: H05RN-F, $3 \times 1.0\text{mm}^2$, O.D:7.3mm, Brown:L, Blue:N, Black: \downarrow

EU model: H05RN-F, $2 \times 1.0\text{mm}^2$, O.D:7.0mm, Brown:L, Blue:N

DC Output Cable(Exposed Length $250 \pm 10\text{mm}$):

EU model: H05RN-F, $2 \times 1.0\text{mm}^2$, O.D:7.0mm, Brown:V+, Blue:V-

DIM Cable(Exposed Length $220 \pm 10\text{mm}$):

UL model: STYLE 21996 2*22AWG, O.D: 4.9mm, Purple: DIM+/DA,

Pink: DIM-/DA

Name Description	Standard Code	mm(In.)
Case Length	L3	149(5.87)
Case Width	W1	66(2.6)
Case Height	H	35(1.38)
Overall Length	L1	165(6.5)
Mounting Hole Length	L2	158(6.22)
Mounting Hole Width	W2	32(1.26)
TC Point Position	X	104(4.09)
TC Point Position	Y	35(1.38)

Note:

1, Please follow the "LED Driver User Manual" obtained from SOSEN's official website for assembly.

2, AC Input Cable, DC O/P Cable, DIM/AUX Power/Programming Cable: Peeled length of cable: $43 \pm 5\text{mm}$, Tinned length of wire: $10 \pm 2\text{mm}$

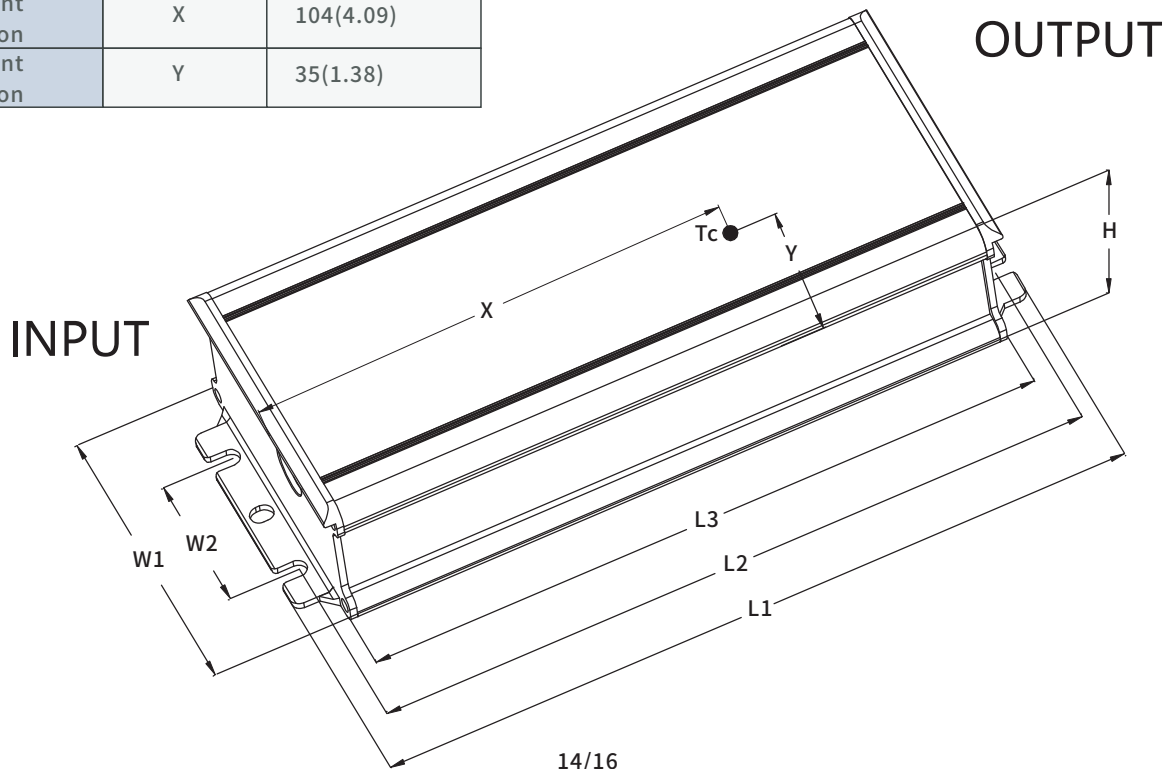

14/16

SS-150GA-E Series LED Driver



Assembly Tips

1. Please take isolation and waterproof measures if the dimming cable is not in use.

Package

- Outside carton dimension: L × W × H = 495mm × 385mm × 162mm;
- 14PCS/Carton;
- Net weight/Piece: 0.68kg; Gross weight/Carton: 11kg;
- Please refer to the product name, model number, manufacturer identification, QC PASS, manufacturing date on the package.

Transportation

Packaging is designed suitable for transportation by trucks, vessels and flights. The products should be avoided direct sunlight and rain, loaded/unloaded with caution.

Storage

The product storage meets the standard of the GB 3873—83.
Products should be rechecked if stored for over 1 year before installation.

RoHS

Products comply with RoHS Directive (2011/65/EU) and amendment 2015/863/EU.

Revision History

Version	Description of Update	Updated Date	Remark
V00	Original Release	2023/10/08	